

# Sierra DENTAL EQUIPMENT INC. 352-527-1975

## TV-22 Dry Vacuum System

2020 USER MANUAL/Installation Instructions



1953 W. Gulf To Lake Hwy, Lecanto, FL 34461

Phone: 352-527-1975 FAX: 352-513-4801

# TABLE OF CONTENTS

<b>Cover</b>	1
<b>Congratulations</b>	2
<b>Customer support</b>	3
<b>Warranty Policy</b>	4
<b>Safety</b>	5
<b>Sub Assemblies</b>	6
<b>What's Included</b>	7
<b>Specifications</b>	8
-Site requirements	8
-Product Specifications	9
-Tank Specifications	10
-Chassis Specifications	11
<b>System Layout</b>	12
<b>Installation</b>	13
<b>Operation</b>	18
<b>Maintenance</b>	19
<b>Troubleshooting</b>	20
<b>Accessories</b>	21

## *Congratulations!*

On the Purchase of your TRU-VAC 22 dry vacuum system. This state of the art dry vacuum is a very powerful, high volume, efficient system. 230 volt motors provide the HP necessary to handle high demands while maintaining multiple operatories. Equipped with a Vortex Action Separator(VAS) Tank, your TRU-VAC dry vacuum system will ensure efficiency and reliability.

**We are certain you will love your new product!**

If you are not satisfied 100% with this products please reach out and let us know, *we are successful because of your FEEDBACK!*

**352-527-1975**

**Email: [sierradentalequipment@outlook.com](mailto:sierradentalequipment@outlook.com)**

# CUSTOMER SUPPORT

“We are happy to help you with any questions or concerns you may have about your equipment”

Contact Us 24/7 We're here to help!

352-527-1975

800-240-5677

[sierradentalequipment@outlook.com](mailto:sierradentalequipment@outlook.com)

[DentalVacuums.com](http://DentalVacuums.com)

Look for us...



on social media!

Sierra Dental Equipment Inc.

1953 W. Gulf to Lake Hwy

Lecanto, FL 34461

# WARRANTY POLICY



## Sierra Dental Equipment Limited Warranty

Warranty for the TRU-VAC Dry Vacuum System is limited to the original purchaser of the unit. Sierra Dental Equipment is only obligated under this warranty to the repair or replacement of defective parts or materials. The defect(s) must be reported to Sierra Dental Equipment within the valid warranty period.

Sierra Dental Equipment will examine the product to determine if the parts are defective. Equipment that has been abused, neglected, or damaged by being improperly installed/maintained are not covered by this warranty. We are not responsible for work performed on the unit by any unauthorized service agents.

## Warranty Period

Warranty is valid only with the return of the warranty card within 30 days of purchase for a period of **10 years**.

## Warranty Service and Return Policy

To obtain warranty service, product must be returned to Sierra Dental Equipment for examination at the purchaser's expense. All returns must be authorized and a return material authorization (RMA#) number must be obtained from Sierra Dental Equipment. Returned units must be properly packaged for shipping. We are not responsible for shipping damages or shipping charges. Sierra Dental Equipment will, at their discretion, repair or replace defective parts. **\*\*PLEASE NOTE\*\*** there is a **25% re-stocking fee** on all returns.

# SAFETY

Use of the TRU-VAC not in compliance with the instructions specified in this manual may result in permanent failure/voided warranty of the unit.

## WARNING

To prevent fire or electrical shock, do not expose this unit to rain or moisture, excessive heat or improper ventilation.

## ATTENTION USERS



Alerts users of important operating and maintenance instructions. Read carefully to avoid any problems



Warns users of a potentially hot surface, and a danger of burns



Warns users that uninsulated voltage is present and can cause electric shock

# SUB ASSEMBLIES



Low voltage control box



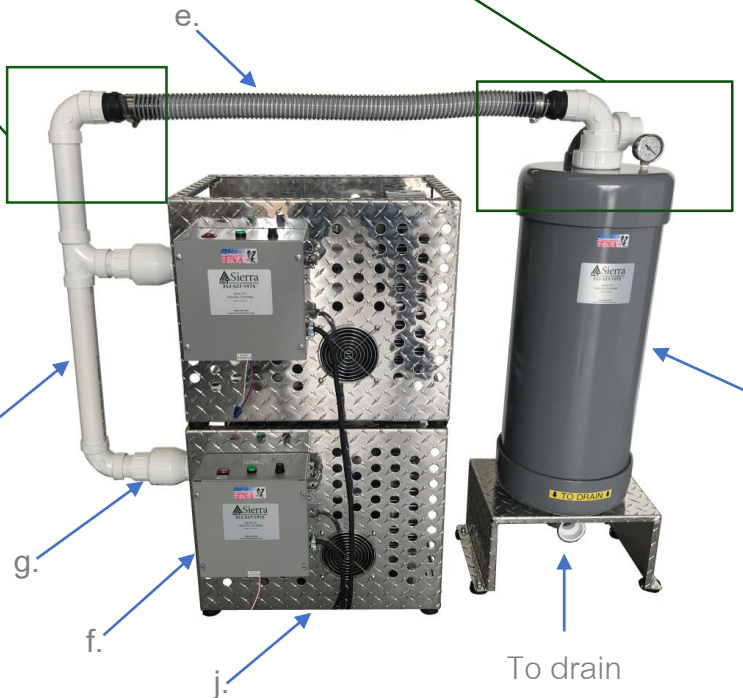
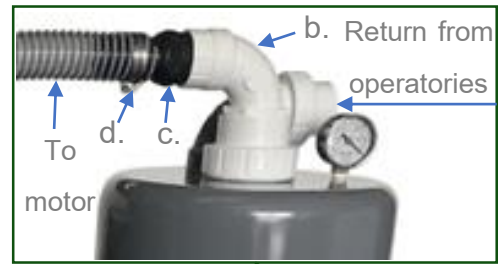
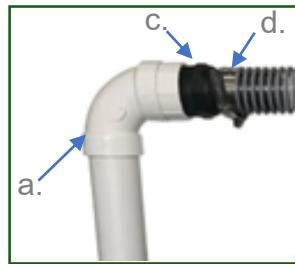
Vortex action separator tank



Motor Assembly

# WHAT'S INCLUDED

- a) X1 90 Degree Elbow.....(1 1/2" Female Slip x 1 1/2" Female Thread DWV)
- b) X1 90 Degree Elbow.....(1 1/2" Street x 1 1/2" Female Thread DWV)
- c) X2 Yellow Fiberglass Reinforced Nipple.....(1 1/2" Male Thread x 1 1/2" Barbed)
- d) X2 Stainless Steel Hose Clamps.....(1 13/16" – 2 3/4")
- e) X1 Vacuum Flex Hose.....(1 1/2" dia. x 5' Length)
- f) X1 Low Voltage Controller.....(24 Volt, Remote Capability)
- g) X2 One way valve.....(1 1/2" Slip adapters included)
- h) X1 VAS Collection Tank.....(12 Gallon, 1 1/2" Female Slip connections)
- i) X1 PVC.....(1 1/2" x 7" Length "To Tank")
- j) X2 Motor Assembly.....(2.4 HP, 1 1/2" Female Slip Inlet, 1 1/4" Male Threaded Outlet "Exhaust")
- k) X1 TV-22.....USER MANUAL
- l) X1 Warranty Card.....(Fill Out And Return within 30 days)



**Sierra Dental Products LLC  
WARRANTY CARD**

\*Must be RETURNED within 30 Days to VALIDATE WARRANTY  
Mail IN or FAX to 352-513-4801

INSTALLATION DATE: \_\_\_\_\_ SERIAL NO.: \_\_\_\_\_  
 PURCHASED FROM: \_\_\_\_\_  
 CUSTOMER NAME: \_\_\_\_\_  
 STREET ADDRESS: \_\_\_\_\_  
 CITY/STATE/ZIP: \_\_\_\_\_  
 PHONE: \_\_\_\_\_ E-MAIL: \_\_\_\_\_

I AM SATISFIED WITH THIS PRODUCT AND YOU MAY USE ME FOR REFERENCES. [ ]  
 WWW.DENTALVACUUMS.COM PHONE: 800-240-5877



# SPECIFICATIONS



## SITE REQUIREMENTS

ELECTRICAL 230 V AC	DUAL (TV-22)
Maximum circuit breaker rating	15 Amp
Minimum wire size	14 Gauge
PLUMBING	DUAL (TV-22)
Minimum exhaust vent pipe	1 ¼" steel pipe (DO NOT USE 90 DEGREE ELBOWS)
Minimum drain line	1 ½" flex pipe 1 ½" Sch. 40 PVC

1 ½" Schedule 40 PVC is recommended for main feed (SUCTION) lines running to operatories from the TRU-VAC.



# SPECIFICATIONS



## PRODUCT SPECIFICATIONS

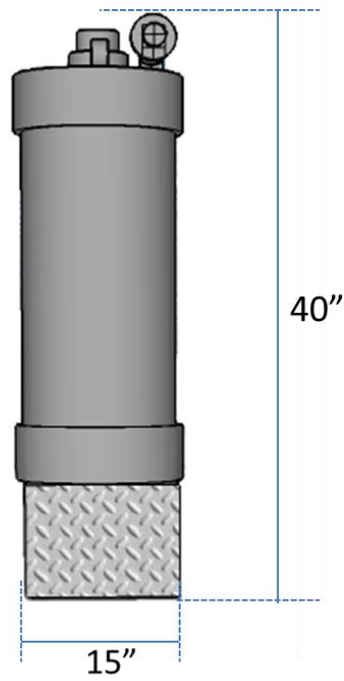
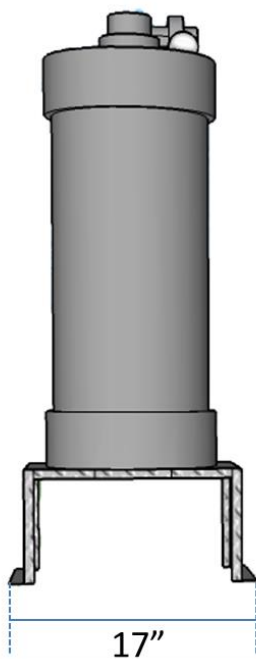
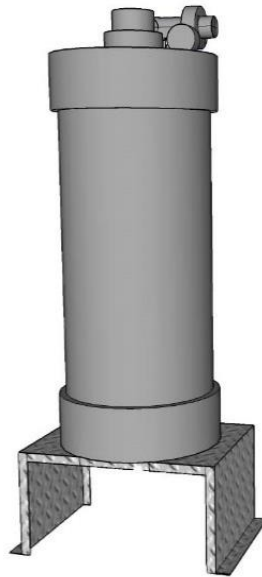
<b>ELECTRICAL</b>	<b>DUAL (TV-22)</b>
Voltage	230 V AC
Operating load	10 Amps
Start-up load	14 Amps
Frequency	50 – 60 Hz
<b>VAS (TANK)</b>	<b>DUAL (TV-22)</b>
Max operators	12 People
Capacity	12 Gallons
<b>Climate requirements*</b>	<b>Acceptable parameters</b>
Ambient temp	41° - 104° F
Max operating temp	214° F
Storage temp	0° - 150° F
Relative humidity	90 % (No humidity)

\*DO NOT store flammable liquids & mixtures  
near this dry vacuum system

# SPECIFICATIONS

## TANK SPECIFICATIONS

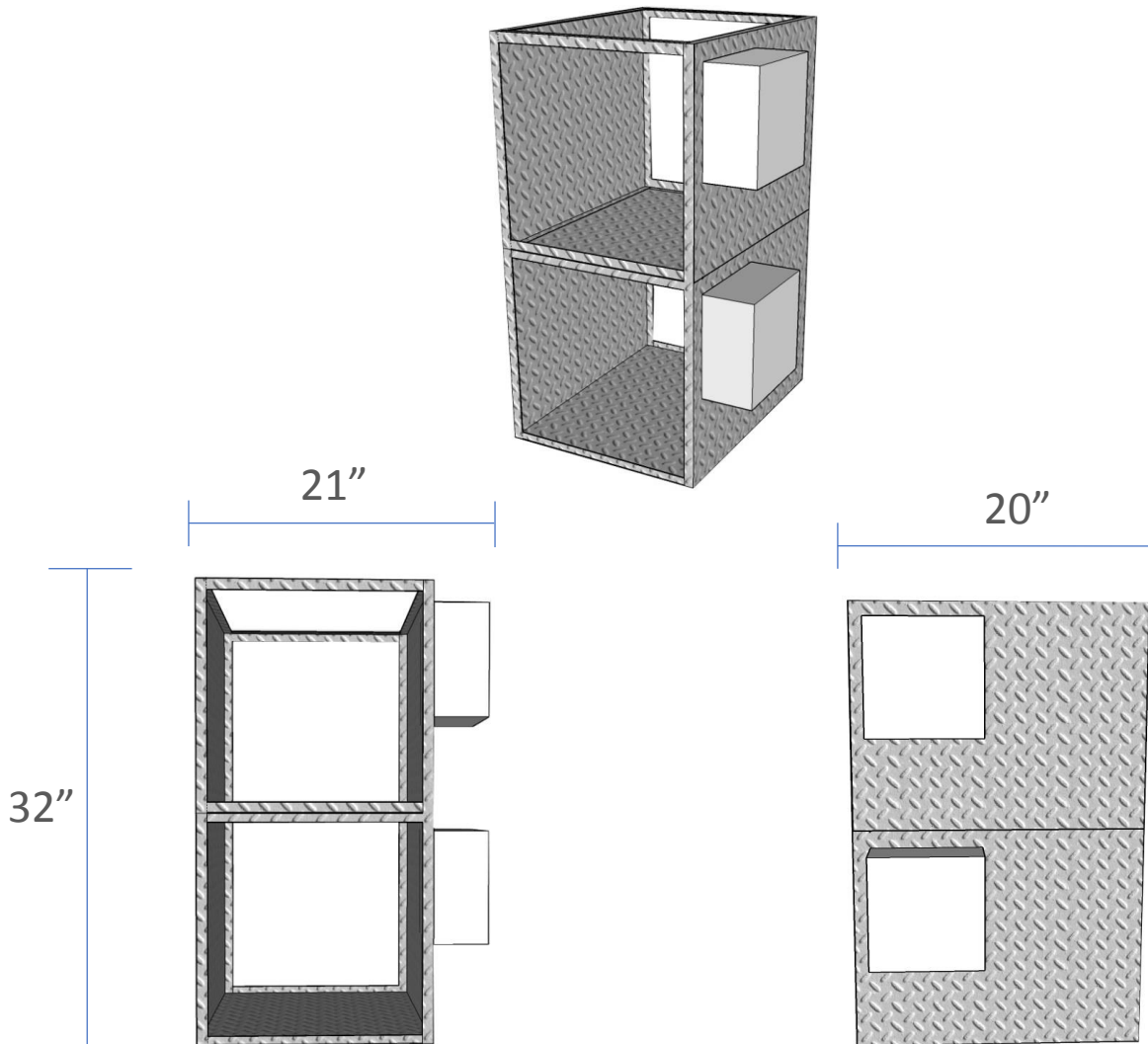
TANK	Weight	Height	Width	Depth	Capacity
V.A.S.	43 lbs.	40"	17"	15"	12 Gal.



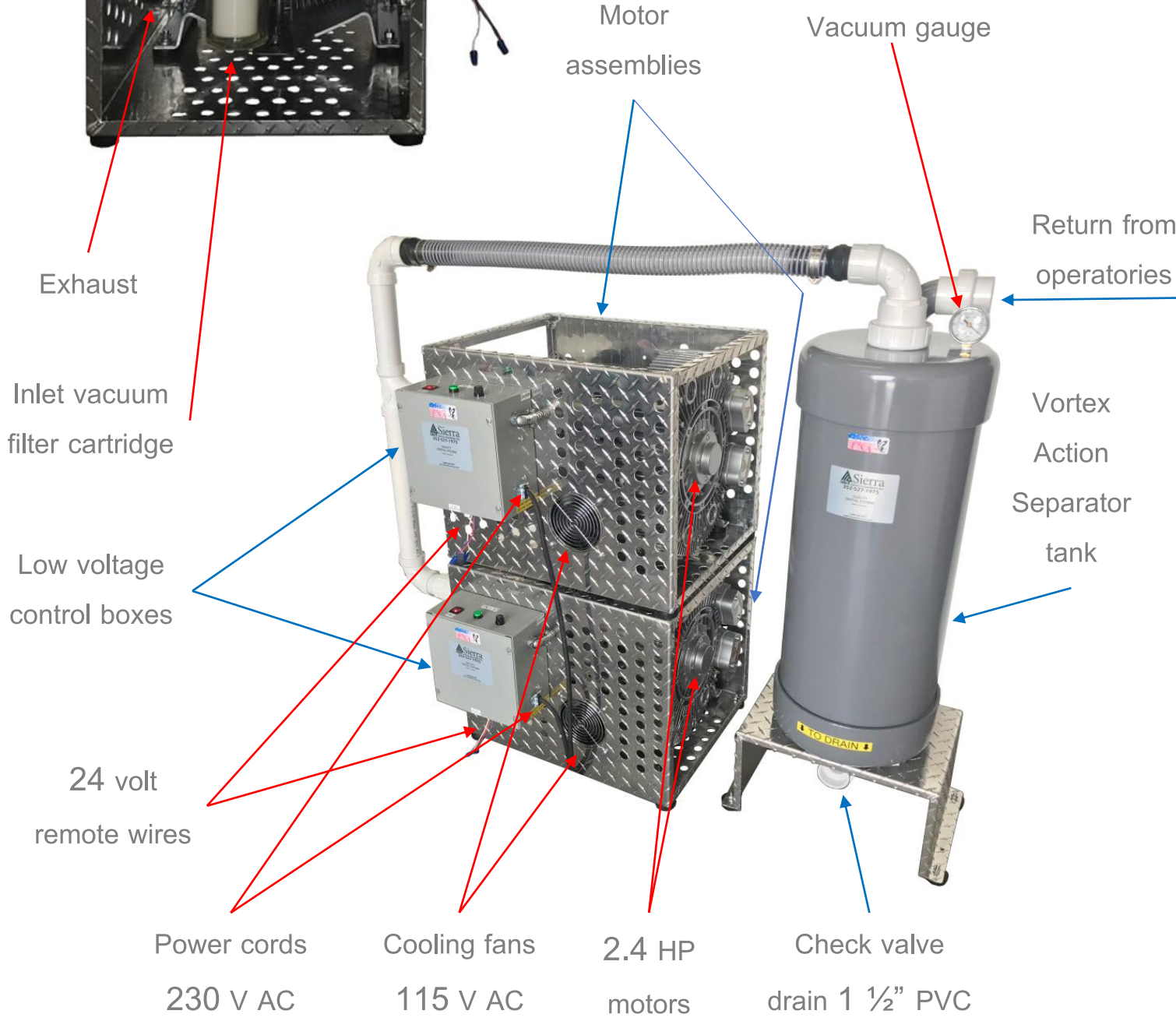
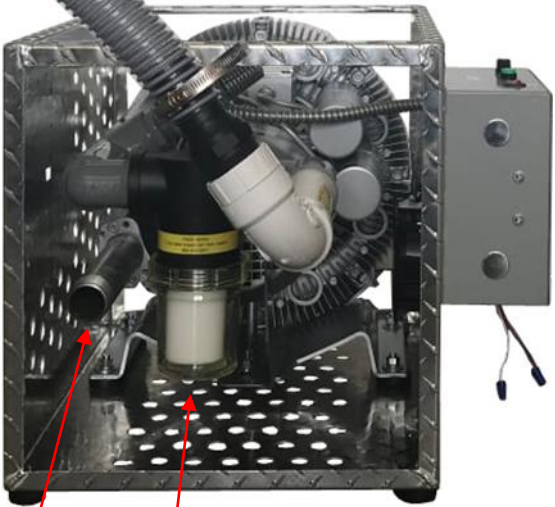
# SPECIFICATIONS

## CHASSIS SPECIFICATIONS

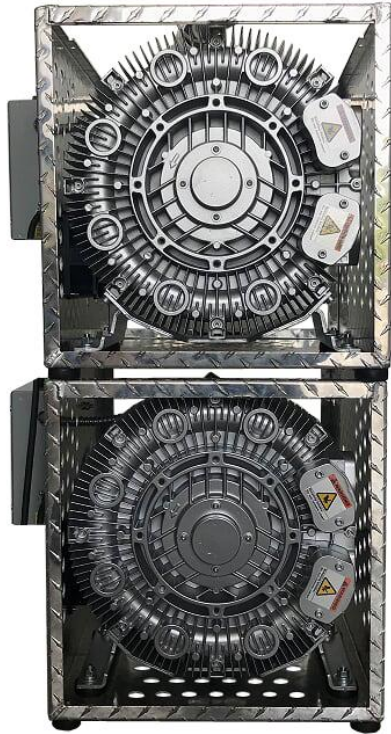
CHASSIS	Weight	Height	Width	Depth
2017	170 lbs.	32"	21"	20"



# SYSTEM LAYOUT



# INSTALLATION



▲ Mount your (VAS) tank on top of the motor assembly or beside it. Tank placement is all according to your specific location requirements.

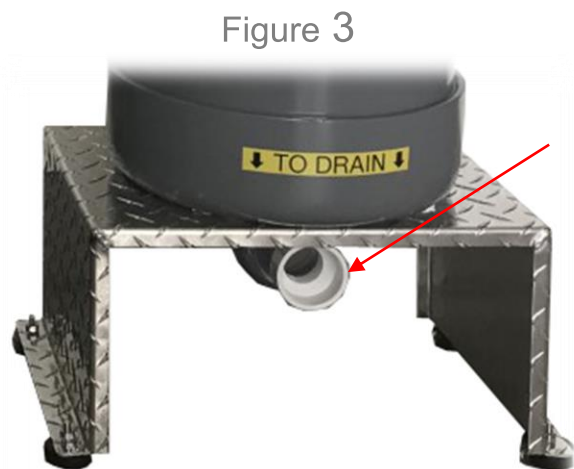
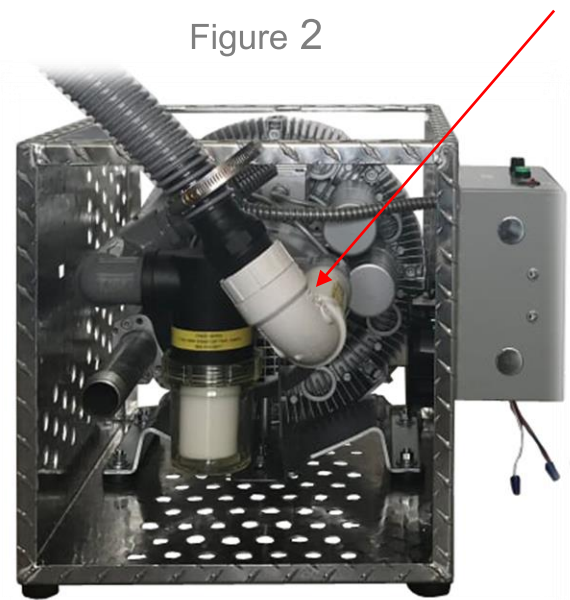
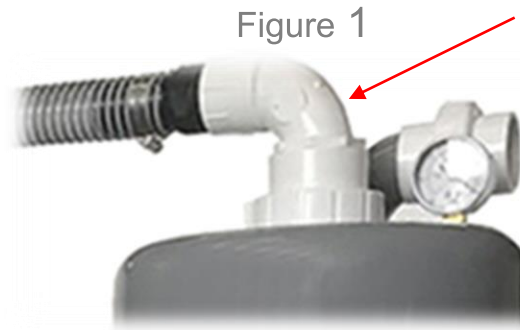
▲ The VAS tank can be installed in an alternate area of the practice if necessary.

▲ Call Sierra Dental Equipment Inc if you have any questions regarding your installation.



# INSTALLATION

1. Find a location that fits the required site specification.
2. Wherever you plan to mount motor assembly, be sure that the 230 volt power source is readily available.
3. Place your motor assembly on the ground, if the (VAS) tank is going to be mounted on top of the motor chassis do so now. Align the 2 holes on tank base to the 2 holes on motor chassis and secure with included hardware
4. Run PVC/Flex Pipe from the top of the tank (Fig. 1) into the motor inlet. (Fig. 2)
5. Connect proper drain to the bottom of the tank and route this to the sewer. (Fig. 3) Assure that the tank drain is at a higher elevation than the sewer inlet to allow the tank to drain properly. (1 ½" Schedule 40 PVC is recommended)



# INSTALLATION



(Fig. 4) Shows the correct positioning for plumbing the motors together. It shows a 90° elbow, this will only be used if your (VAS) tank is mounted beside the two motor assemblies. If this is the case, then you will cut a section of flex hose that can reach from the motor inlet, to the tank inlet. Slip the yellow nipples in the hose ends, and be sure to tighten these down with the provided hose clamps. This will be the connection between your motors and your (VAS) tank. \*If your system will have the (VAS) tank mounted above the two motor assemblies **DON'T** use the 90° elbow. Cut a big section of flex hose that can reach from the motor inlet, to the tank inlet. Slip the yellow nipples in the ends, and be sure to tighten these down with the provided hose clamps. This will be the connection between your motors and your (VAS) tank.

Figure 4



(Blue arrows to show air flow)

# INSTALLATION

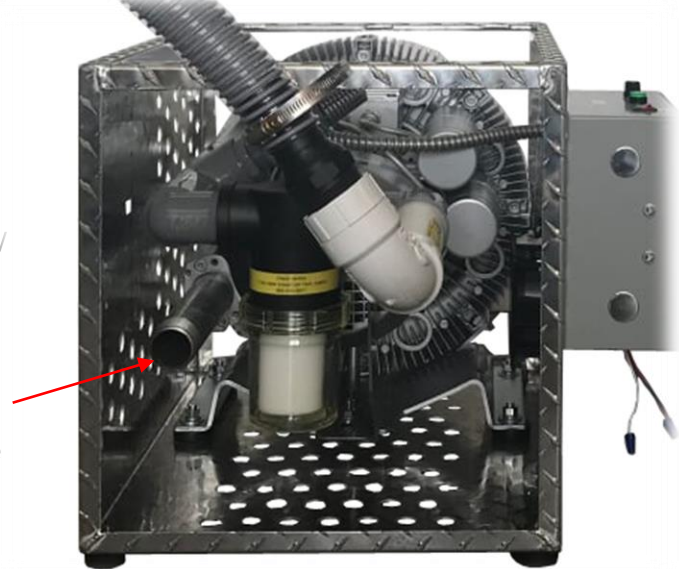


6. Connect the pre-existing operatory lines to the tank. (Fig. 5) Unless you plan to run all new lines.
7. We provide a 1 ¼" – 8" steel pipe exhaust. (Fig. 6) Route exhaust with this same material or similar high temp flex pipe to an outside vent. DO NOT USE 90° ANGLE. 45° ANGLES RECOMMENDED
8. Routing the exhaust to an outside vent is very important, this reduces the heat significantly. This will ensure that any odor will leave the building. Wherever the exhaust leaves the building assure that outside elements such as rain/snow or foreign objects cannot make its way into the exhaust. This could potentially cause harm to the motor. The easier the exhaust can flow out of the motor with minimum restriction, the cooler the system will run. This will prolong the life of the motor. Keep in mind when routing the exhaust, excessive length and multiple turns will create more restriction.

Figure 5



Figure 6





# INSTALLATION



10. Route and connect the motor assembly power cord (Fig. 6) to a \*230 volt source. Maximum circuit breaker rating: 15 AMPS per motor. \*Box supplied by customer.

**Green = Ground**  
**Black = L1**  
**White = L2**

\*Connections are to be made  
by a certified electrician\*



Figure 6

11. (Optional) On the underside of the low voltage controller you will find three remote wires. (Fig. 7) Route these wires to a location where you will be mounting the remote operation switch panel to control the system.

**Red = 28 Volt power**  
**Blue = Return**  
**White = Illumination (lamp)**



Figure 7

# OPERATION



Use the red rocker switch (Fig. 7) to turn the control box on & off.

Green light indicates ON (Fig. 8)  
If the system will not turn on.

Always check this fuse first (Fig. 9)  
Only replace with 2.5 amp fuse!

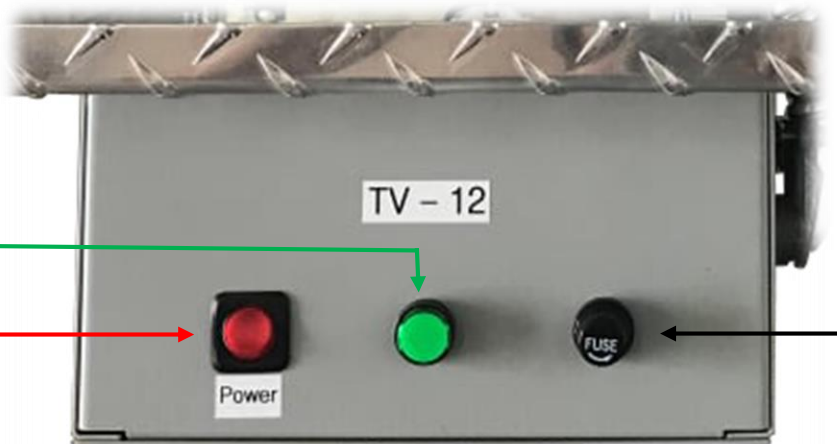


Figure 7



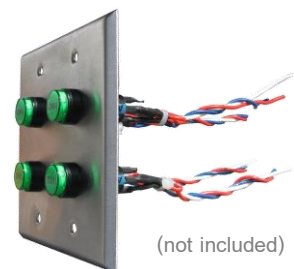
Figure 8



Figure 9

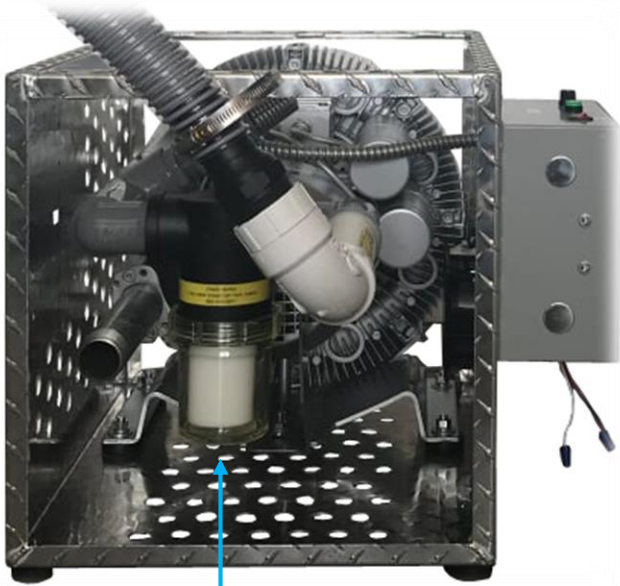


Figure 10



For use with an alternate remote switch ensure that the red rocker switch (Fig. 7) is on, and the alternate remote switch is wired correctly to the 24 volt remote wires. This Feature will allow you to control your system with a remote switch (Fig 10).

# MAINTENANCE



**\*ALWAYS** make sure that your filter is WHITE & CLEAN, a bi weekly check is highly recommended. These micron filters are not reusable, do not attempt to clean or alter the filter in any way. Dirty filters should always be replaced every 3-6 months **#RMC-10** New filters are purchased thru Sierra Dental. (Contact us via phone, email, or visit us on the web)

⚠ Other than filter replacement, your new TRU-VAC is virtually maintenance free with its reliable oil-less & water-less pump!

⚠ Your TRU-VAC should be mounted in a clean environment, dust and debris can potentially harm your unit and cause malfunction not covered under warranty. (The Vacuum relief valve pulls air from the environment, so dust and debris can freely enter the motor if it is mounted incorrectly.)

**⚠ DO NOT ATTEMPT TO ADJUST THE VACUUM RELIEF VALVE**

The vacuum relief valve is a preset part, Sierra Dental Equipment Inc. has set the standard for this valve according to many variables. Adjusting the vacuum relief valve, will void your warranty.

⚠ **Intermittently** check to ensure that your cooling fan is still running.(If it is not on while the motor is running contact us)

⚠ **Intermittently** check your drain connection on the bottom of the (VAS) tank to ensure that it is dry and not leaking.

# TROUBLESHOOTING



ISSUE	POSSIBLE CAUSE	POSSIBLE SOLUTION
No suction	<ul style="list-style-type: none"> <li>a) Pump not turned on</li> <li>b) Pump not running</li> <li>c) VAS tank is full</li> <li>d) Drain check valve clogged</li> <li>e) Kinked or collapsed hose</li> </ul>	<ul style="list-style-type: none"> <li>a) Turn pump on</li> <li>b) Contact Sierra Dental</li> <li>c) Shut unit off for 20 seconds then turn unit back on</li> <li>d) Contact Sierra Dental</li> <li>e) Call your local plumber</li> <li>f) Call Sierra Dental</li> </ul>
Poor or low suction	<ul style="list-style-type: none"> <li>a) Restricted air exhaust</li> <li>b) Restricted air suction</li> </ul>	<ul style="list-style-type: none"> <li>a) Ensure that exhaust is ran according to installation procedure, call Sierra Dental</li> <li>b) Dirty filter, Contact Sierra Dental</li> </ul>
Pump does not run	<ul style="list-style-type: none"> <li>a) 230 V circuit breaker is OFF</li> <li>b) Remote switch is OFF or not correctly connected</li> <li>c) Electrical issue</li> </ul>	<ul style="list-style-type: none"> <li>a) Turn the circuit breaker ON</li> <li>b) Make sure remote switch is ON, call Sierra Dental</li> <li>c) Call Sierra Dental</li> </ul>

# ACCESSORIES

Line cleaner



Bio-Pure is an environmentally friendly, non-corrosive evacuation system cleaner that restores and maintains evacuation system flow and function by actively breaking down and digesting organic waste. Eliminate years of sludge build up in as little as 6 weeks and prevent new sludge from sticking around, even in between applications!

Amalgam separator



We've helped doctors everywhere find their solution to amalgam in the waste water! Want to become amalgam compliant and reduce your environmental impact? Call us to find out how we can help you with our simple and easy options. From becoming compliant all the way through the recycling process, Sierra has your back every step of the way!

Replacement filters



REPLACEMENT FILTERS – available in packs of 3. (Filters are a very important factor with your TRU-VAC.)

A dirty filter will cause loss of vacuum and motor damage. Inspecting and replacing these filters regularly ensures proper maintenance procedures and avoids down time or costly repairs.